

ASSEMBLY INSTRUCTIONS MODEL 9583N

REMOVE ALL ITEMS FROM THE CARTON. VERIFY ALL PIECES BEFORE ASSEMBLY

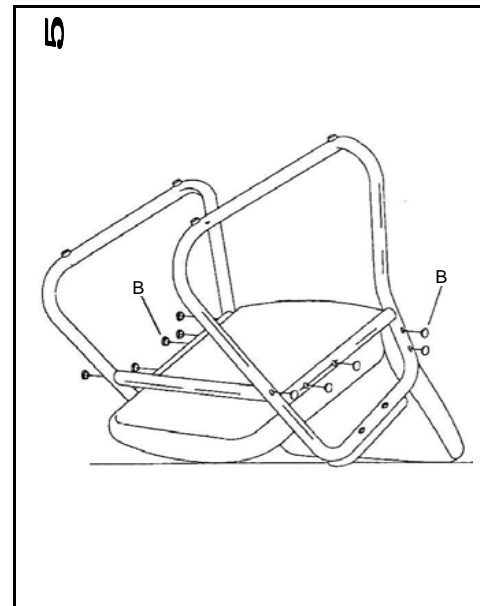
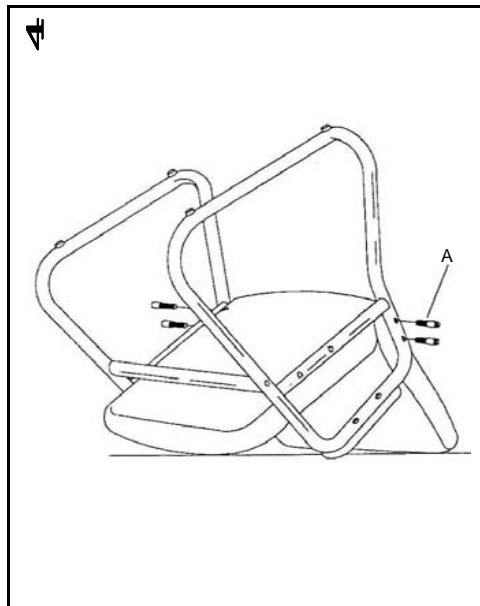
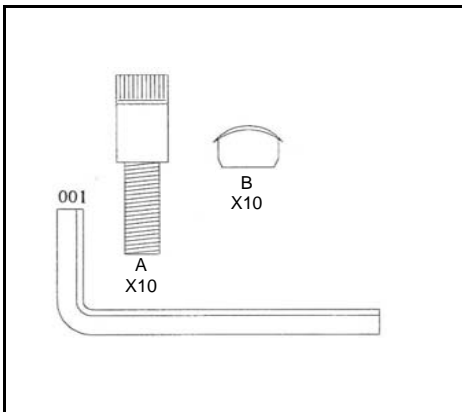
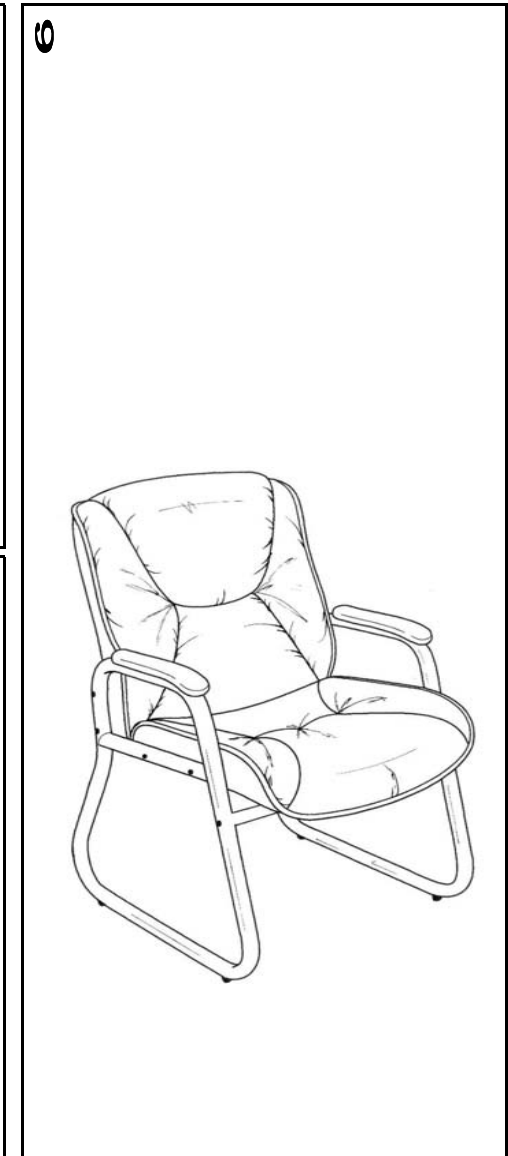
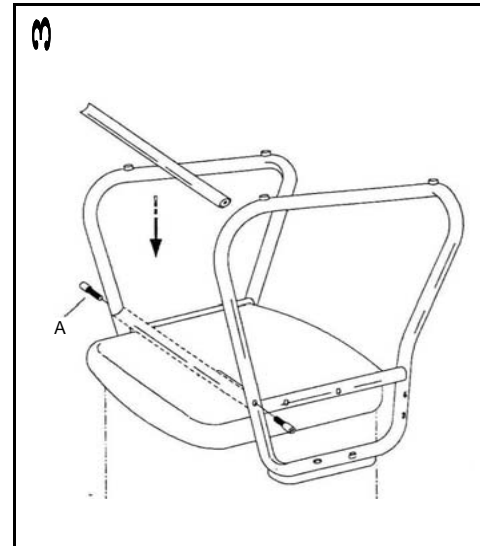
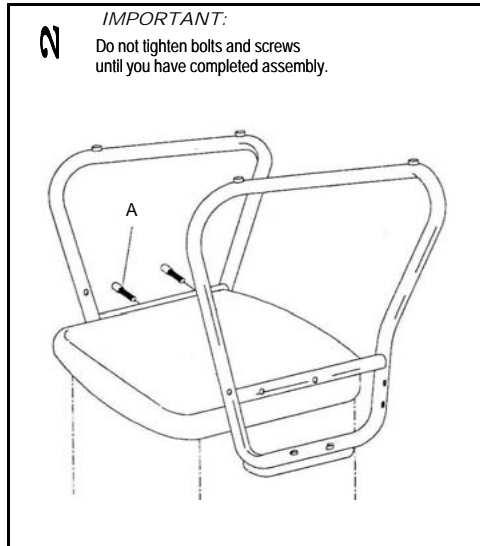
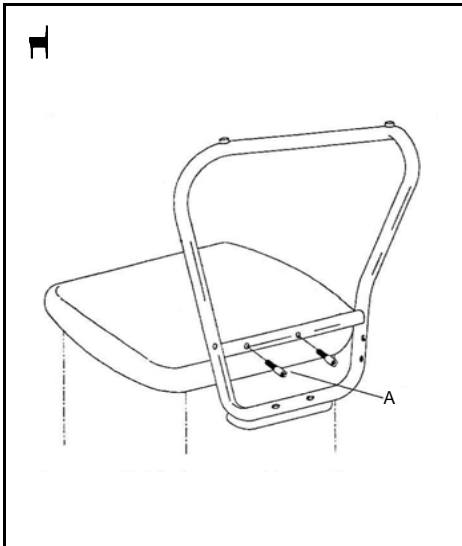

		QTY
A	SCREW	10
B	PLASTIC CAP	10
001	ALLEN WRENCH FOR SCREWS (A)	1

PREVENTATIVE MAINTENANCE AND WARNING

USE THIS PRODUCT ONLY FOR SEATING ONE PERSON AT A TIME
 DO NOT USE CHAIR AS STEP STOOL/LADDER
 DO NOT USE CHAIR UNLESS ALL BOLTS, SCREWS ARE TIGHT
 CHECK AND RETIGHTEN ALL BOLTS, SCREWS EVERY 6 MONTHS

ANY QUESTIONS PLEASE CONTACT

CHAIRWORKS AMERICA
 755 RACK DRIVE, SUITE A
 LAWRENCEVILLE, GA 30046
 1-888-217-2577